

User Manual

Applicable Models

SR43AA
SR49AA
SR55AA
SR65AA
SR75AA
SR86AA

 Before using this product, please read the user manual carefully and properly keep it for future reference.

Safety precautions



Warning: Use of controls, adjustments, or processes not described in this document may lead to collisions, electrical hazards, or mechanical hazards.
Operation of this equipment in a residential environment could cause radio interference.



- Warning:
- Do not ingest battery. Chemical Burn Hazard!
 - This product contains a coin/button cell battery. If the coin/button cell battery is swallowed, it can cause severe internal burns in just 2 hours and can lead to death.
 - Keep new and used batteries away from children.
 - If the battery compartment does not close securely, stop using the product and keep it away from children.
 - If you think batteries might have been swallowed or placed inside any part of the body, seek immediate medical attention.
 - CAUTION: Risk of explosion if the battery is replaced by an incorrect type.
 - Improper replacement of the battery with an incorrect type may defeat a safeguard (for example, in the case of some lithium battery types).
 - Do not dispose of the battery into fire or a hot oven, or mechanically crush or cut the battery, which may result in an explosion.
 - Do not leave the battery in an extremely high temperature surrounding environment, which may result in an explosion or the leakage of flammable liquid or gas.
 - Do not subject the battery to extremely low air pressure, which may result in an explosion or the leakage of flammable liquid or gas.
 - Dispose of used batteries according to the instructions.



Please read and observe the following precautions when connecting and using the display:

Operation:

- Do not expose the display to direct sunlight and keep it away from any heat source.
- Move away any objects that may fall into the ventilation hole or object that may prevent the normal heat dissipation of the electronic components of the display.
- Do not block the ventilation hole on the shell.
- When placing the display, make sure that the power plug and socket are easy to plug and unplug.
- If the display has just been turned off by unplugging the power cord, you must wait 6 seconds before reconnecting the power cord to ensure normal operation.
- Be sure to use the approved power cord provided by BOE. If the power cord is missing, please contact the local service center.
- Protect the display from violent vibration or collision during use.
- Do not knock or drop the display during use or transportation.
- Adjust to the off state when not watching to reduce the energy consumption.
- On the premise of ensuring the viewing quality, the energy consumption of the display in use can be reduced by reducing the brightness of the display.

Maintenance:

- To protect the display from damage, do not press the LCD panel too hard. When moving the display, grasp the frame to lift it up; when lifting, do not put your hands or fingers on the LCD panel.
- If the display is not used for a long time, the power plug of the display shall be unplugged.
- When cleaning the display with slightly wet cloth, the power plug of the display shall be unplugged. When the power supply is off, the screen can be wiped with dry cloth. However, do not use organic solvents (e.g. alcohol) or liquids containing ammonia to clean the display.

- To avoid electric shock or permanent damage to the display, do not use the display in a dusty, rainy, or excessively humid environment or the environment near water.
- If the display gets wet or is affected with damp, wipe it with dry cloth as soon as possible.
- If water enters the display, turn off the power immediately and unplug the power cord. Then, send the display to the maintenance center for over-haul.
- Do not store or use the display in hot or cold places or places exposed to direct sunlight.
- In order to maintain the best performance of the display and ensure a longer service life, please use it under the temperature and humidity conditions described in the specification.

Important: When the display is unattended, be sure to start the mobile screen saver. If the display shows static content, be sure to enable the periodic screen refresh application. "Imprinting" may be caused on the screen if the display shows still or static image for a long time without interruption, and it is also known as "residual image" or "after image". This is a common phenomenon of LCD panel technology. In most cases, after turning off the power supply for a certain period of time, the "imprint", "residual image" or "after image" will gradually disappear.

Warning: Serious "imprinting", "residual image" or "after image" will not disappear and cannot be repaired. This is not covered by the warranty. Repair:

- Only professional maintenance personnel can open the shell cover.
- If the product needs repair or integration, please contact the local service center.

Do not place the display in places exposed to direct sunlight.



If you operate as described in this document but the display does not work normally, please contact the technician or the local service center.



If you operate according to the instructions in this manual but the display does not work normally, please consult the technical service personnel.

- Keep the display dry. To avoid electric shock, do not expose the display to rain or damp.
- The disconnecting device of this product is the power plug, and the socket provided for the display shall be installed near the display, be easy to operate, and not be blocked by other objects.

Contents

1. Unpacking and Installation	1
1.1. Unpacking.....	1
1.2. Articles in the Packing Box	1
1.3. Installation Precautions	2
1.3.1. Wall Mounting	2
2. Parts and Functions	3
2.1. Input / Output Terminals.....	3
2.2. Remote Controller	5
2.2.1. Installation of Remote Controller Battery	7
2.2.2. Maintenance of Remote Controller	7
2.2.3. Operating Range of Remote Controller.....	7
2.3 Home Screen Functional Operation Guide	9
2.3.1. Home Screen-Input	10
2.3.2. Home Screen-Smart Cast	11
2.3.3. Home Screen- File Manager	12
2.3.4. Home Screen- Settings	13
2.3.4.1 Settings-Network	14
2.3.4.2 Settings-Network-LAN	15
2.3.4.3 Settings-Network-HotSpot	16
2.3.4.4 Settings-Picture-Picture Mode	17
2.3.4.5 Settings-Picture-color Temperature	18
2.3.4.6 Settings-Picture-Noise Reduction	19
2.3.4.7 Settings-Picture-Reset	20
2.3.4.8 Settings-Sound	21
2.3.4.9 Settings- General-Date &Time	22
2.3.4.10 Settings- General-Rotation	23
2.3.4.11 Settings- General- Language	24
2.3.4.12 Settings- General- OSD Display Time	25
2.3.4.13 Settings- General- Power-on Mode	26
2.3.4.14 Settings- General- On/Off Timer	27
2.3.4.15 Settings- General- HDMI	28
2.3.4.16 Settings- General- Apps Management	29
2.3.4.17 Settings- General- Engineering Menu	30
2.3.4.18 Settings- General- Engineering Menu-No Signal Sleep	31
2.3.4.19 Settings- General- Engineering Menu-No Operation Sleep	32

2.3.4.20 Settings- General- Engineering	
Menu- Power On Delay	33
2.3.4.21 Settings- General- Engineering	
Menu- Device ID	34
2.3.4.22 Settings- General- Engineering	
Menu- Anti-image-Sticking Mode	35
2.3.4.23 Settings- General- Engineering	
Menu- Signal Failover	36
2.3.4.24 Settings- General- Engineering	
Menu- Boot Auto-Start.....	37
2.3.4.25 Settings- General- Engineering	
Menu- Boot Logo	38
2.3.4.26 Settings- General- Engineering	
Menu- No Signal Image	39
2.3.4.27 Settings- General- Engineering	
Menu- Test Mode	40
2.3.4.28 Settings- General- Engineering	
Menu- Safe Mode	41
2.3.4.29 Settings- General- Engineering	
Menu- Password Change	42
2.3.4.30 Settings- General- Reset	43
2.3.4.31 Settings- Update	44
2.3.4.32 Settings- About	45
3. Technical Specifications	46
4. Serial Port Control Protocol.....	50
5. Cleaning and Troubleshooting	54
5.1. Cleaning	54
5.2. Troubleshooting	55

1. Unpacking and Installation

1.1 Unpacking

- This product is packed in a carton and attached with standard accessories.
- Any other options are packed separately.
- Considering the size and weight of this display, it is recommended that this display should be carried by two persons.
- After opening the carton, please confirm that the articles are complete and intact.

1.2 Articles in the Packing Box

Please confirm that the following articles are contained in the packing box:

- LCD, remote controller, manual, two AAA batteries, power cord, screw sticker, and wire management buckle.



Display



Remote Controller



AAA battery

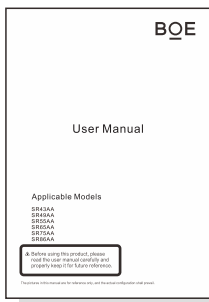

User Manual



IR receiver



Power cord

Note:

- You can keep the packing box and packing materials for future transportation of the display.

1.3. Installation Precautions

1.3.1 Wall Mounting

I.
Take the whole unit out of the packing box;

II.
Place the unit face down on a firm surface with protection underneath it such as a blanket or sheet. Ensure there is no debris under the screen before placing it down.

III.
Install the wall-mounted bracket of the display into the wall-mounting hole site with the wall-mounted screws (43"/49"/55"/65"/75"/86": M8x12mm), lock and fix it.

IV.
The distance from the wall mounting points is following VESA mount sizes
43":400x200mm,
49"/55":400x300mm,
65"/75": 400x400mm,
86": 600x400mm

Please carefully check whether the screws have been installed in place to avoid potential safety hazards. The company will not be responsible for any damage to people or objects caused by rough operation or force.

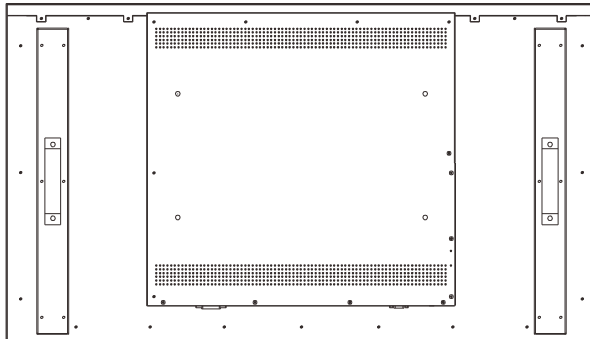

2. Parts and Functions

2.1. Input / Output Terminals

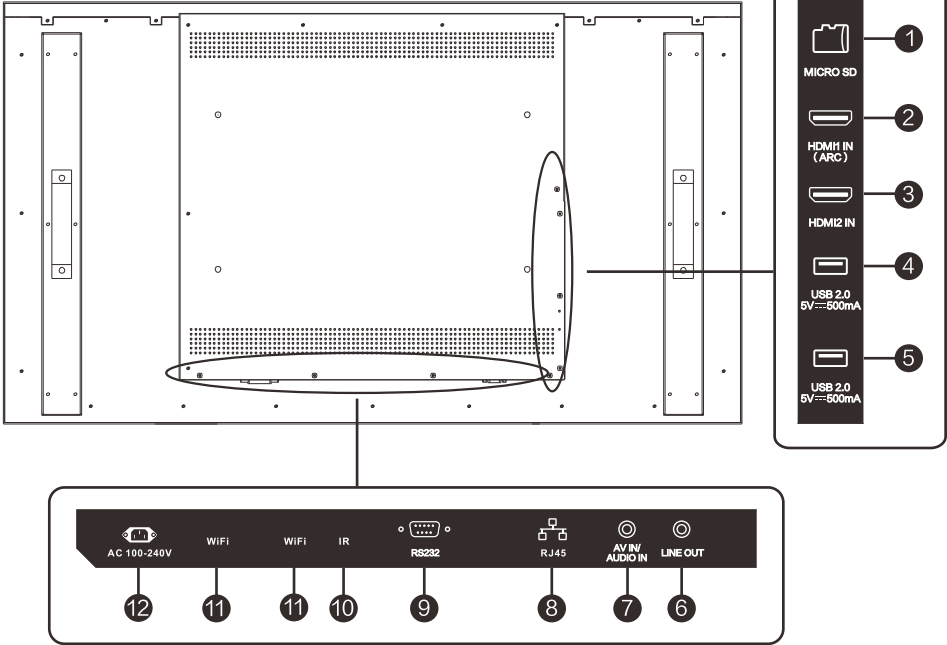

No.	Name	Description
1	MICRO SD	TF card storage
2	HDMI1	HDMI2.0 input 1
3	HDMI2	HDMI2.0 input 2
4	USB2.0	USB2.0 interface
5	USB2.0	USB2.0 interface (local upgrade interface)
6	LINE OUT	Audio output
7	AV_IN/AUDIO IN	Audio and video input interface
8	LAN	10/100M network interface
9	RS232	RS232 serial port communication
10	IR	Remote control sensor
11	WiFi	Wifi Antenna
	AC 100-240V	Power input

Note:

If the display cannot be used normally after it is connected to AV_IN wire, please cross the sequence of three wires in AV_IN.

AV_IN line sequence definition:

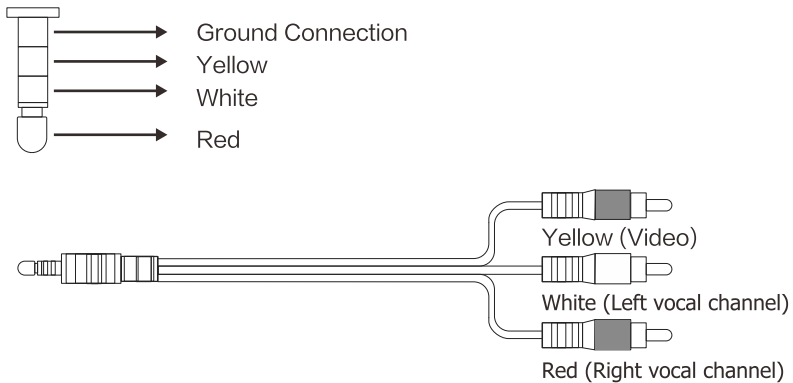

2.2. Remote Controller

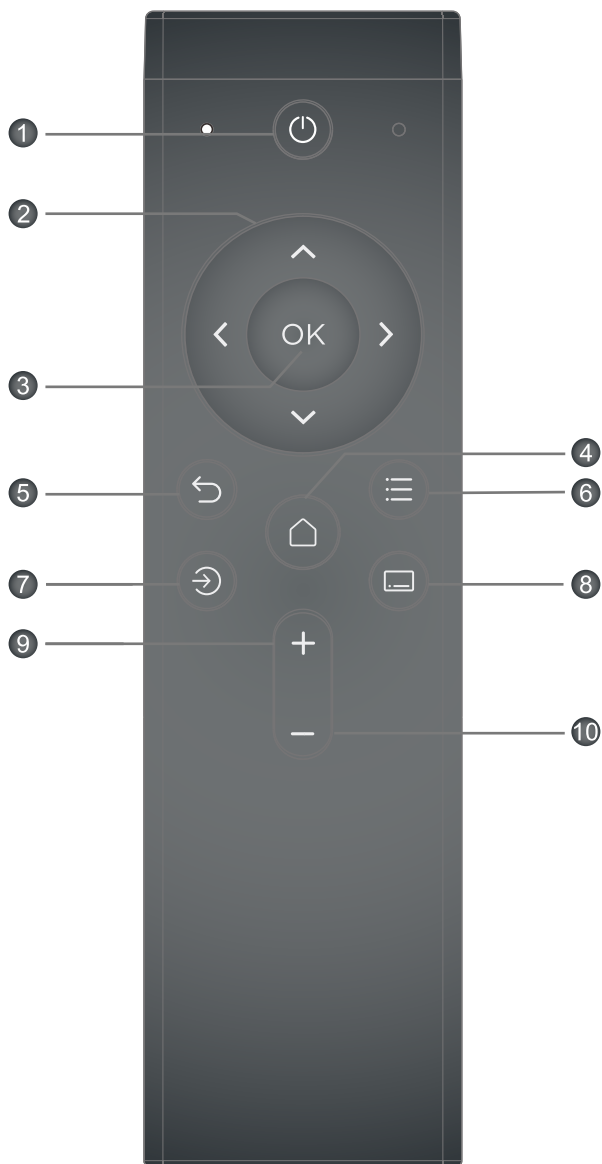

1. Power on/Power off

2. Up, down, left, right

- Movement and selection functions.
- In application, the key value defined by the application is preferred.

3. OK

4. Homepage

In any case, click the Homepage to return to the homepage.

5. Back

- Return to the previous level or exit.
- In application, the key value defined by the application is preferred.

6. Menu

- Call up or close the setting bar.
- In application, the key value defined by the application is preferred.
- In browser and WPS application, the mouse mode and the remote control mode can be switched by one key.

7. Channel switching

Call up or close the channel switching bar.

8. Quick navigation

Call up or close the quick navigation bar.

9. Volume +

Click +1, press and hold for 2s to accelerate, and the volume will increase rapidly.

10. Volume -

Click -1, press and hold for 2s to accelerate, and the volume will decrease rapidly.

2.2.1. Installation of Remote Controller Battery

The remote controller is powered by two AAA dry batteries. Installation or replacement of the batteries:

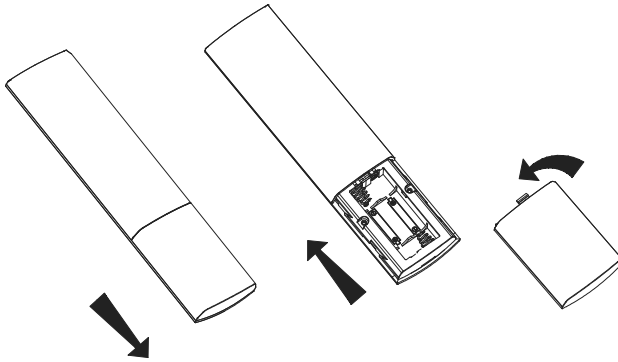

Caution:

Improper use of the battery may cause leakage or bursting. Be sure to observe the following instructions:

- When placing the dry battery, make the (+) and (-) marks on the dry battery correspond to the (+) and (-) marks on the bracket.
- The battery shall be taken out immediately when it has no electricity to prevent leakage in the battery compartment. Do not touch the exposed battery acid; otherwise, the skin will be damaged. Note: The battery shall be taken out when the remote controller is not used for a long time.

2.2.2. Maintenance of Remote Controller

- Protect it from severe collision.
- Void spilling water or other liquids onto the remote controller, If liquid is spilled onto the remote controller, wipe it up immediately.
- Do not turn on the remote controller except for installing the battery.

2.2.3. Operating Range of Remote Controller

Please plug the IR receiver into the IR port on the back of the panel and then the receiver must be placed somewhere visible to the user. When pressing the remote controller button, point the front of the remote controller to the remote control sensor (front) on the display. Use the remote controller within the effective range shown in the table below.

Operating angle	Operating distance
$\theta=0^\circ$ (horizontal and vertical)	0~6m
$\theta=15^\circ$ (horizontal and vertical)	0~6m
$\theta=30^\circ$ (horizontal only)	0~6m

Note: When the sunlight or other strong light shines on the remote control sensor of the display, or there is an obstacle between the remote controller and the remote control sensor, the remote controller may not work normally.

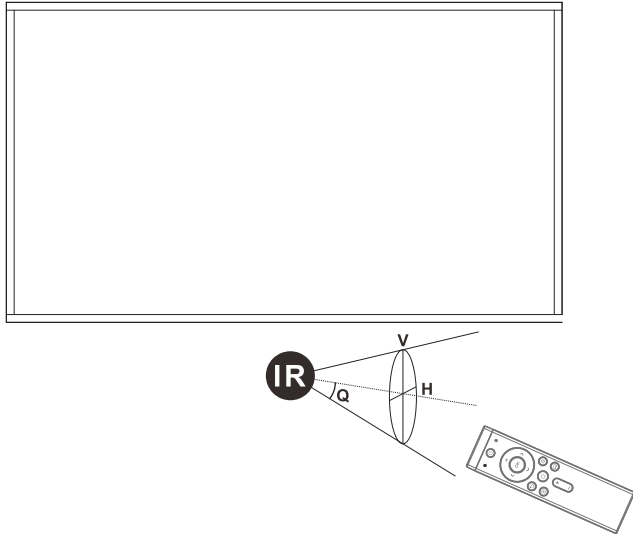

2.3 Home Screen Functional Operation Guide

- Panel will display the below image on initial start-up.
- Use remote control directional keys and “OK” key to access the various menu items at the bottom of the screen:
 - Settings – Access all key picture & panel settings.
 - Inputs – Select your input HDMI1/HDMI2/AV.
 - BOE Cast – Quickly transfer images from phone or tablet device to panel.
 - File Manager – Explore file directory of the panel and any connected storage devices, e.g. USB flash drive, USB Hard Drive or SD Card.
 - Time and date are displayed at top left and can be edited in settings.
 - Connectivity status is displayed top right and can be edited in settings.

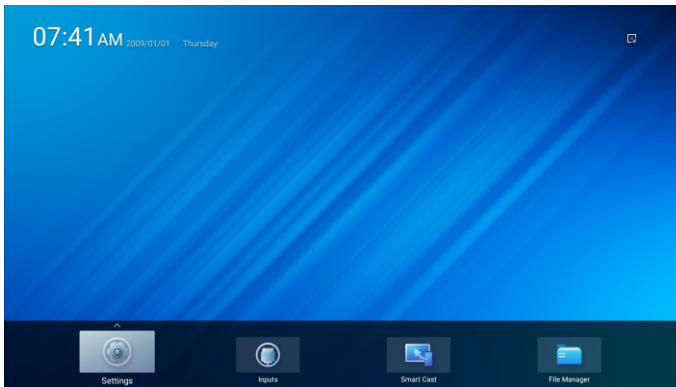

2.3.1 Home Screen-Input

- Using the remote control select the relevant input you are using.
- HDMI 1, HDMI 2, AV In.

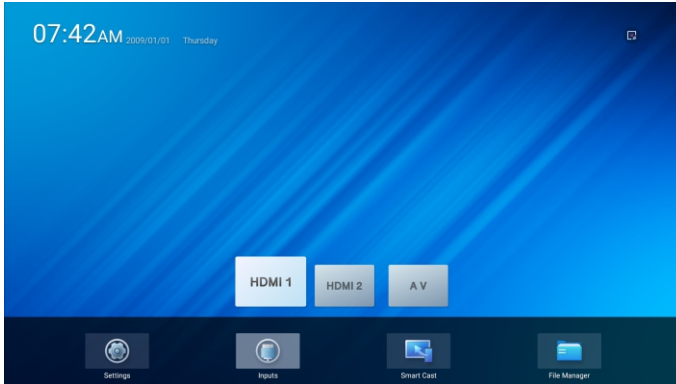

2.3.2 Home Screen-Smart Cast

- Smart Cast allows for you to easily transfer images from your phone or table to the panel via QR code.
- Open the Smart Cast App and follow on screen instructions.
- Ensure TV & phone/tablet are on the same wifi network.

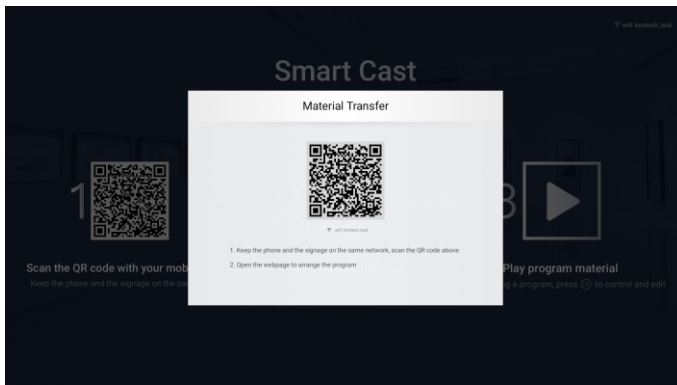

2.3.3 Home Screen- File Manager

- The File Manager app allows you to explore the internal memory of the panel and any connected media devices such as USB Drives, USB Hard Drives and SD Cards.
- The left panel displays the internal storage of the panel, as well as any connected storage devices.
- At the top you will find the menu layout including:
 - All Files – Display all types of files on the selected storage device. Please note this panel runs on an Android 9 Operating System so you will find operating system files here. Please refrain from editing or deleting any of these.
 - Video – Display all video file types quickly.
 - Picture – Display all picture file types quickly.
 - Music – Display all audio file types quickly.
 - Others – Display remaining file types quickly.
- In the top right hand side you will find a search feature to quickly find a specific file name or file type.

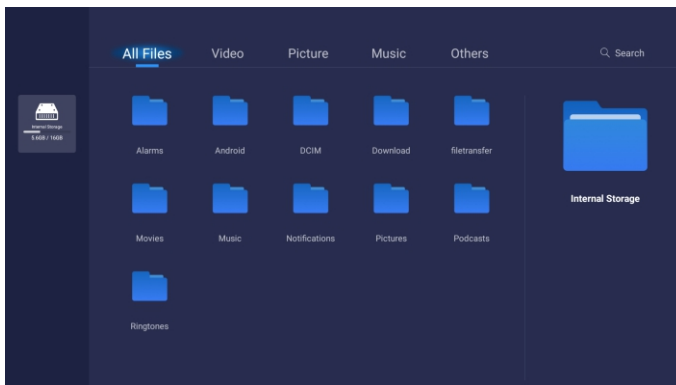

2.3.4 Home Screen- Settings

- When selecting the Settings icon you will be presented with a new menu on the left side of the screen which contains:
 - Network – Adjust network settings – Wifi, Hotspot, LAN connections.
 - Picture – Adjust picture settings – Colour, positioning, tone.
 - Sound – Adjust sound settings.
 - General – Adjust device name, language, time, panel orientation, power on state, On/Off timer, HDMI management, Apps management, Engineering Menu, System Reset.
 - Update – Check for a firmware update via an internet connection or local file.
 - About – Detailed information about the panel and operating system.

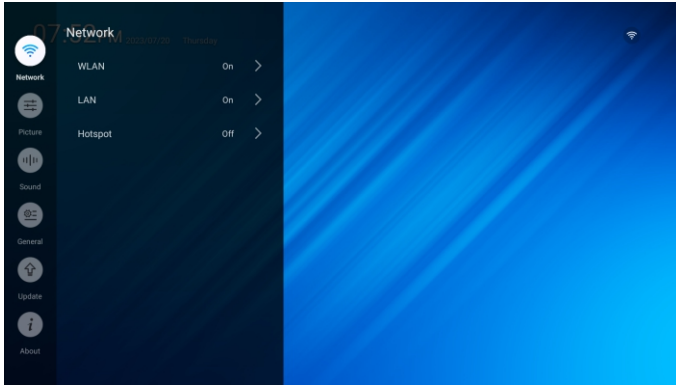

2.3.4.1 Settings-Network

- Network – Adjust network settings – Wifi, Hotspot, LAN connections.
 - WLAN – Wireless LAN – On/Off.
 - Once enabled, displays a list of available networks to connect to.
 - To connect to a network, select the appropriate option and press OK. Enter security details if applicable.
 - LAN – On/Off – Displays LAN & IP Settings.
 - Hotspot – On/Off – Broadcast the LAN connection as a Wi-Fi connection for other devices. Disables WLAN.

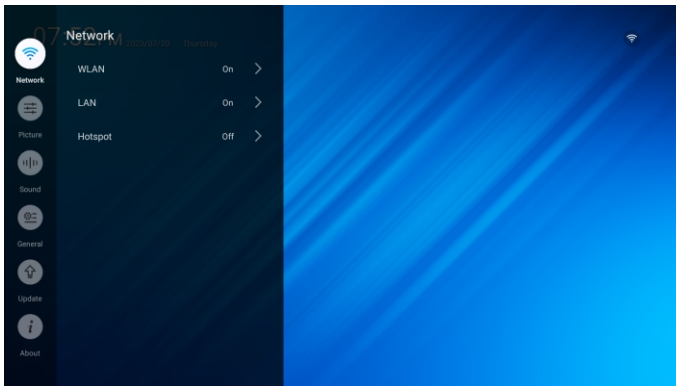

2.3.4.2 Settings-Network-LAN

- LAN On/Off.
- IP Settings – Auto(DHCP)/Manual.
 - Displays or allows editing of:
 - IP Address.
 - Gateway Address.
 - Subnet Mask Address.
 - DNS Address.

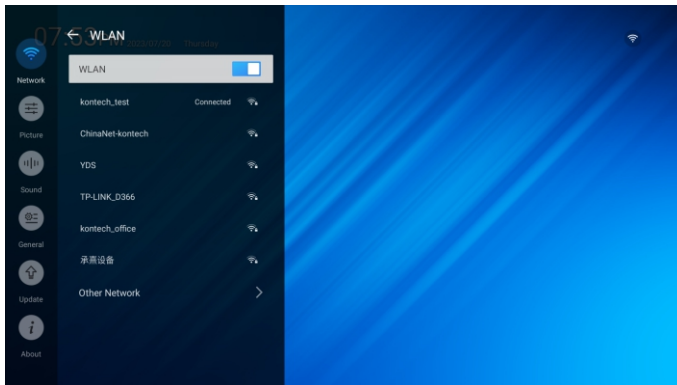

2.3.4.3 Settings-Network-HotSpot

- Hotspot On/Off.
- Hotspot Settings.
 - Displays or allows adjustment of hotspot details.
 - Hotspot name.
 - Encryption (WPA/WPA2) On/Off.
 - Encryption password.

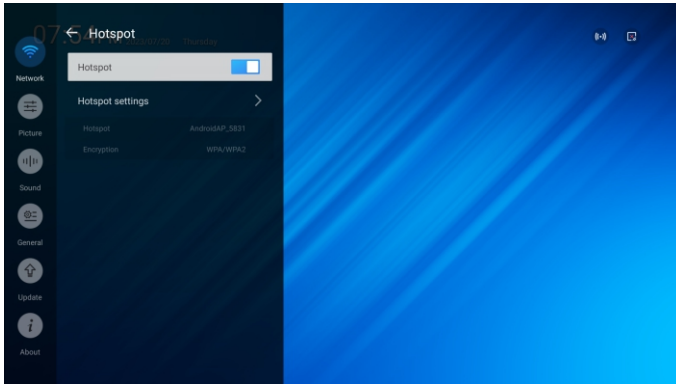

2.3.4.4 Settings-Picture-Picture Mode

- Picture – Adjust picture settings – colour, positioning, tone.
- Picture Mode – Cycle through pre-configured colour and contrast profiles.
 - Standard, Vivid, Soft, Natural, User.
- Values are editable in each profile (0-100).
 - Backlight level
 - Brightness level
 - Contrast level
 - Saturation
 - Hue
 - Clarity
 - Gamma

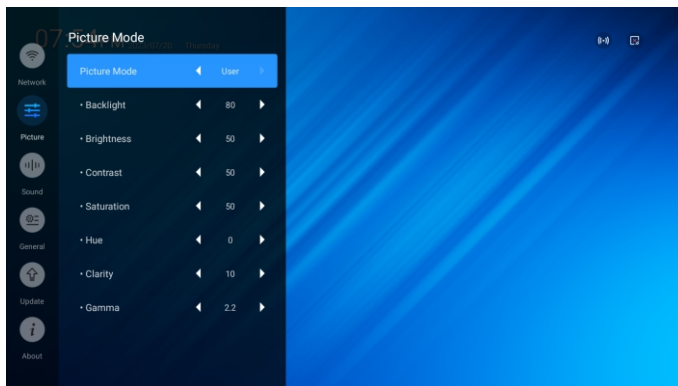
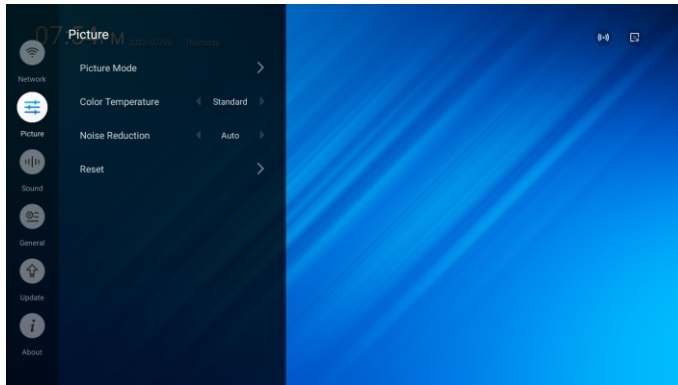

2.3.4.5 Settings-Picture-color Temperature

- Colour Temperature – Adjust the colour/temperature of the panel.
 - Standard
 - Warm
 - Cold
 - User

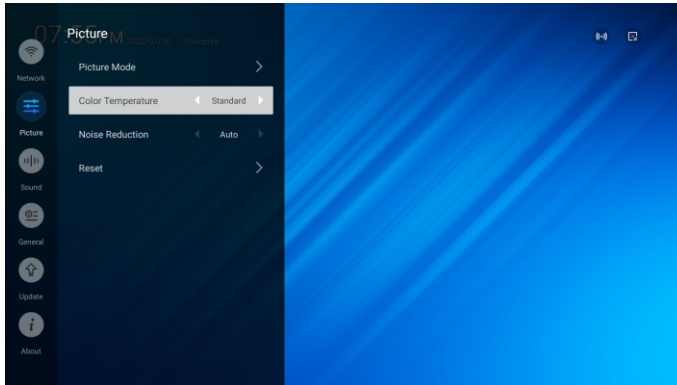

2.3.4.6 Settings-Picture-Noise Reduction

- Noise Reduction – Adjust the level of panel processing to reduce noise in the picture.
- Auto – Analyses the content noise and automatically applies Low, Medium or High noise reduction processing on the content.
- Low – Implements a low noise reduction process on all content.
- Medium – Implements a medium noise reduction process on all content.
- High – Implements a high noise reduction process on all content.
- Off – Noise reduction is turned off and the source content is played without any panel noise reduction applied.

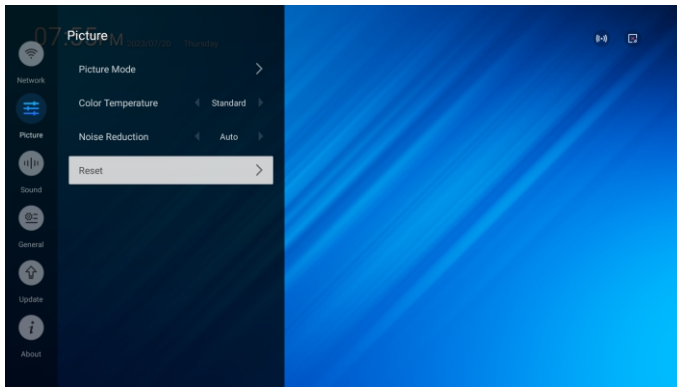

2.3.4.7 Settings-Picture-Reset

- Reset All Picture Colour/Tone/Brightness settings back to default.
- Select and confirm via Reset pop up window.

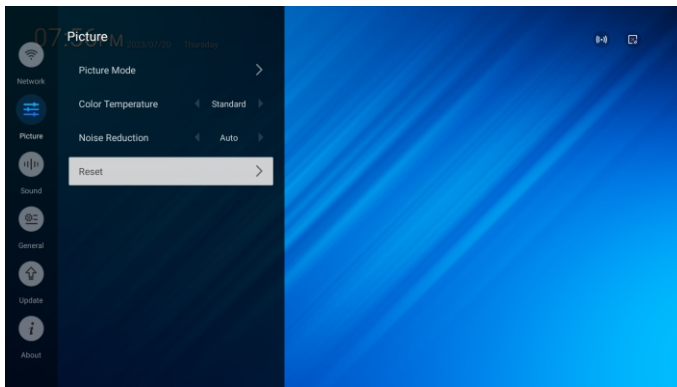
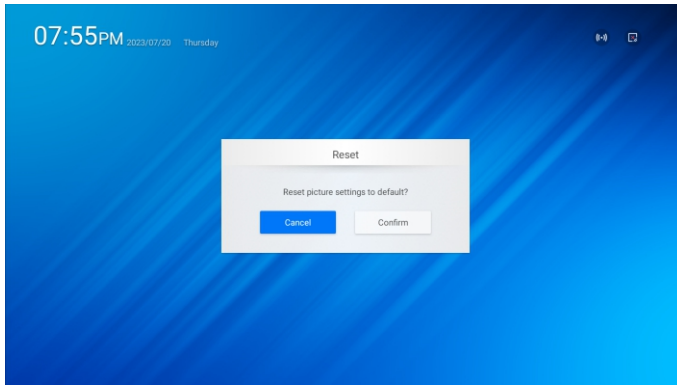

2.3.4.8 Settings-Sound

- Sound – Adjust output settings of on-board speakers or audio out.
- Balance – Change the audio channel in use left or right by selecting balance and using pressing left or right on the remote control to shift the audio balance from left channel to right channel.
 - '0' value means audio is perfectly balanced between left and right channels.
- Volume – Increase or decrease volume.

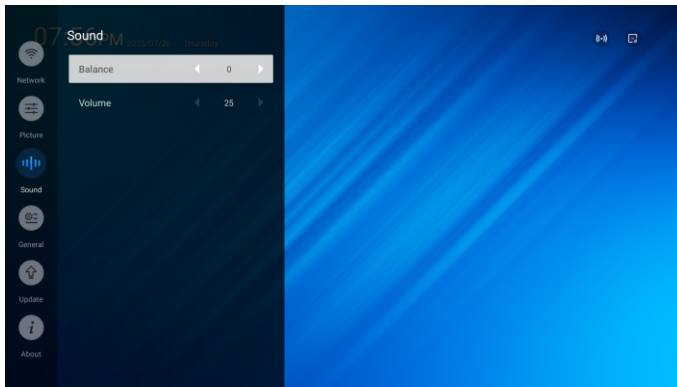

2.3.4.9 Settings- General-Date &Time

- Date & Time allows for adjustment of the following:
 - Time Mode (Auto/Manual).
 - Auto Mode will set time via network connection.
 - 24 Hour or 12 Hour Format.
 - Time Zone.

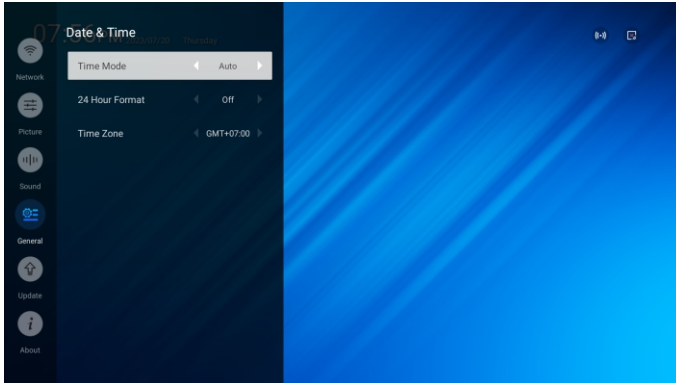

2.3.4.10 Settings- General-Rotation

- Rotation allows for panel Homepage and Menu OSD orientation to be changed.
 - Landscape.
 - Portrait.
- Adjust by selecting with 'OK' button on remote control and then use the direction 'right/left' on the remote control to change between landscape & portrait.

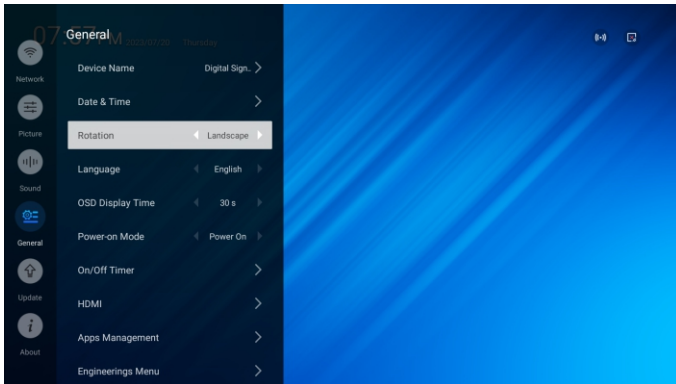

2.3.4.11 Settings- General- Language

- Select between English and Chinese
- Adjust by selecting with 'OK' button on remote control and then use the direction 'right/left' on the remote control to change between languages.

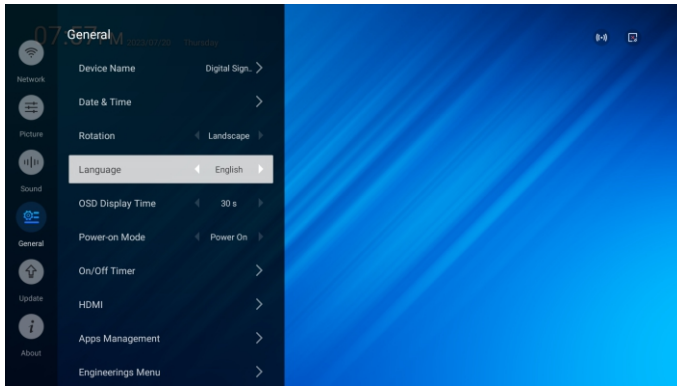

2.3.4.12 Settings- General- OSD Display Time

- OSD Display Time – On Screen Display Time is how long the menu structure or system messages remain visible on the screen after the last interaction with the panel.
- Cycle through 30 second increments.
- Adjust by selecting with 'OK' button on remote control and then use the direction 'right/left' on the remote control to change between the increments.

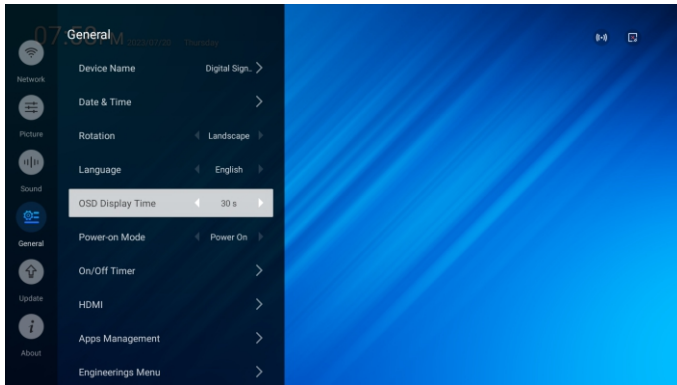

2.3.4.13 Settings- General- Power-on Mode

- Power-on Mode sets what state the panel turns on to when AC power is provided to it.
- Power On – Panel turns on and displays the home screen.
- Last Status – Panel turns on and displays the last input status the panel had (Home screen, HDMI 1, HDMI 2, AV In).
- Standby – Panel remains in standby mode.
- Adjust by selecting with 'OK' button on remote control and then use the direction 'right/left' on the remote control to change between the different statuses.

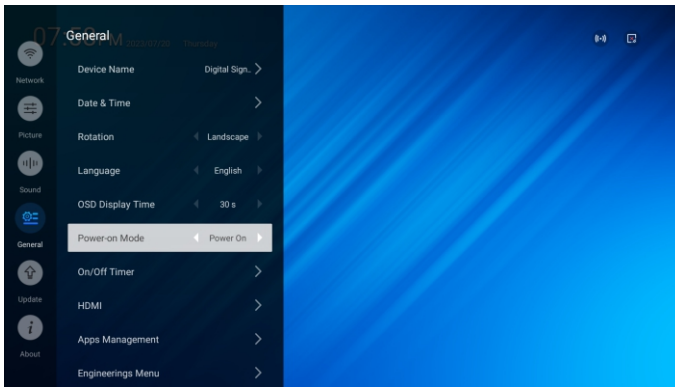

2.3.4.14 Settings- General- On/Off Timer

- On/Off Timer sets a timer for the panel to both turn on and turn off a specific days, hours and minutes.
- Cycle through the following options for both the On Time & Off Time.
- Off – No time is set .
- Everyday – All days (Monday, Tuesday, Wednesday, Thursday, Friday, Saturday & Sunday) the panel will turn on/off at this time.
- Working Days – Weekdays (Monday, Tuesday, Wednesday, Thursday & Friday) the panel will turn on/off at this time. Not on weekend days.
- Weekend Days – Weekend (Saturday & Sunday) the panel will turn on/off at this time. Not on weekdays.
- Hour & Minute can be set for both on/off timers in 24 hour format.
- Adjust by selecting with 'OK' button on remote control and then use the direction 'right/left' on the remote control to change between the different statuses.

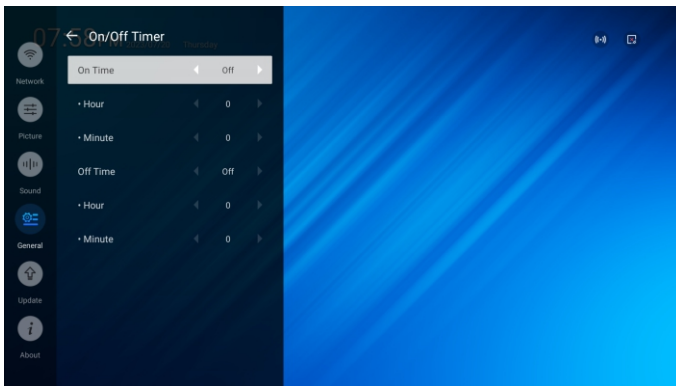

2.3.4.15 Settings- General- HDMI

- HDMI Options can be adjusted here.
- CEC Control – On/Off – adjusts CEC functionality which allows an external device (eg, digital media player with CEC) to turn on or off the panel when an on/off command is passed to the panel via an HDMI signal.
- Device Off Automatically – On/Off – Power off connected HDMI devices via the display.
- Signage On Automatically – On/Off – Power on the display via connected HDMI device.
- Adjust by selecting with 'OK' button on remote control and then use the direction 'right/left' on the remote control.

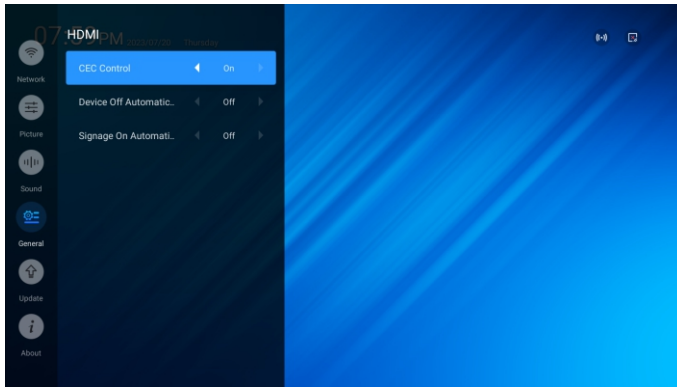

2.3.4.16 Settings- General- Apps Management

- Displays a list of installed Apps.
- Selecting each app displays the amount of memory used on the internal storage of the panel and allows for clearing of app cache data.
- Clearing app cache data may in some cases see performance improvements to the app.
- Clearing app cache data may delete any account or settings data.
- Adjust by selecting with 'OK' button on remote control and then use the direction 'right/left' on the remote control to change between the different statuses.

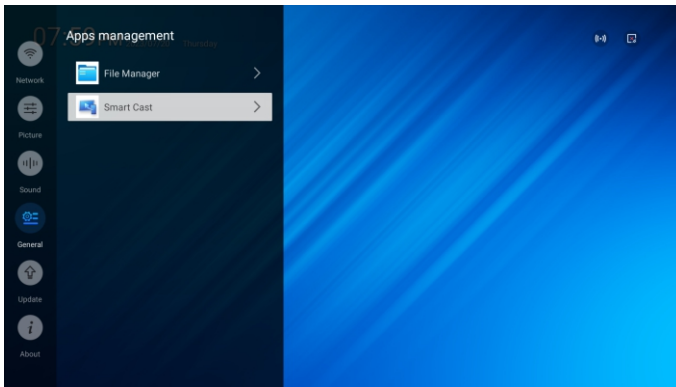

2.3.4.17 Settings- General- Engineering Menu

- The Engineering Menu allows for a professional installer or technician to access technical aspects of the panel.
 - No Signal Sleep
 - No Operation Sleep
 - Power On Delay
 - Device ID
 - VDW Mode
 - Anti Image Sticking
 - Signal Failover
 - Boot Auto Start
 - Boot Logo
 - No Signal Image
 - Test Mode
 - Settings Clone
 - Safe Mode
 - Password Change
- When accessing the engineering menu for the first time, you will be prompted to set a 4 digit numeric password.

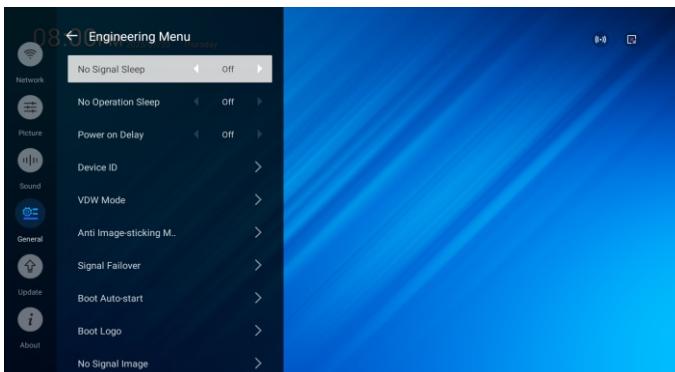
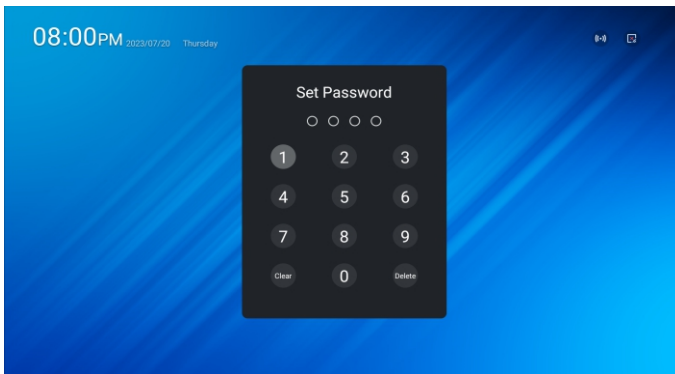

2.3.4.18 Settings- General- Engineering Menu-No Signal Sleep

- No Signal Sleep – Adjust the time in minutes before the panel will enter into a sleep state if no signal is received from a selected input (HDMI 1, HDMI 2, AV In).
 - Off – Panel remains on at all times.
 - 5/10/15/20/30 minute counter.
 - Adjust by selecting with 'OK' button on remote control and then use the direction 'right/left' on the remote control to change between the different statuses.

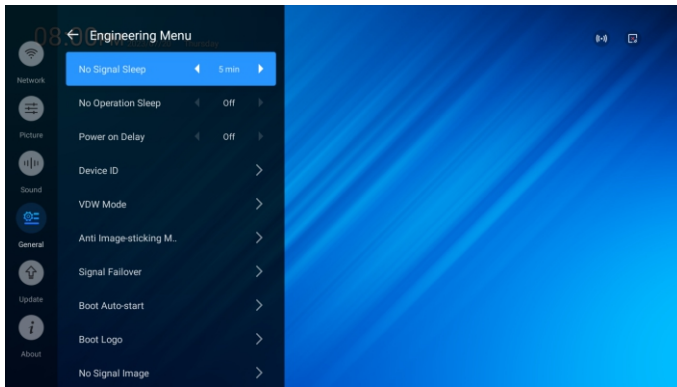

2.3.4.19 Settings- General- Engineering Menu-No Operation Sleep

- No Operation Sleep – adjust the time in minutes before the panel will go into a sleep state if no operation is detected from either remote control interaction or from an app.
 - Off – Panel remains on at all times.
 - 5/10/15/20/30 minute counter.
 - Adjust by selecting with 'OK' button on remote control and then use the direction 'right/left' on the remote control to change between the different statuses.

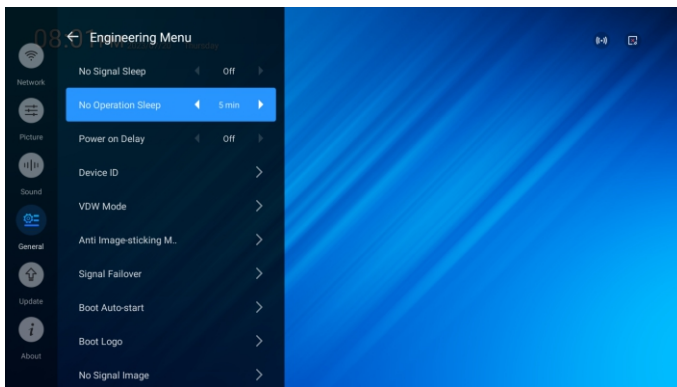

2.3.4.20 Settings- General- Engineering Menu- Power On Delay

- Power On Delay – Adjust the delay time in seconds (s) time the panel will take before powering on.
 - Off – No delay is set, panel will power on as soon as power is provided.
 - 5/10/15/20/30 second delay.
- Adjust by selecting with 'OK' button on remote control and then use the direction 'right/left' on the remote control to change between the different statuses.

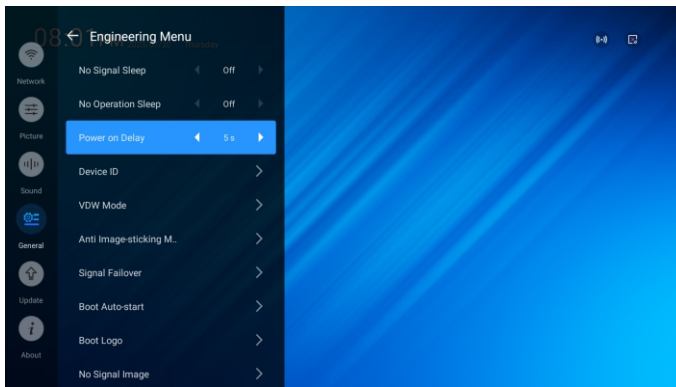

2.3.4.21 Settings- General- Engineering Menu- Device ID

- Device ID – Set the Device ID for RS-232 control.
- Controlled Device ID – Showing the under controlling Device ID.
- Reset – Reset the device ID & Controlled Device ID numbers.
- Adjust by selecting with 'OK' button on remote control and then use the direction 'right/left' on the remote control to change between the different statuses.

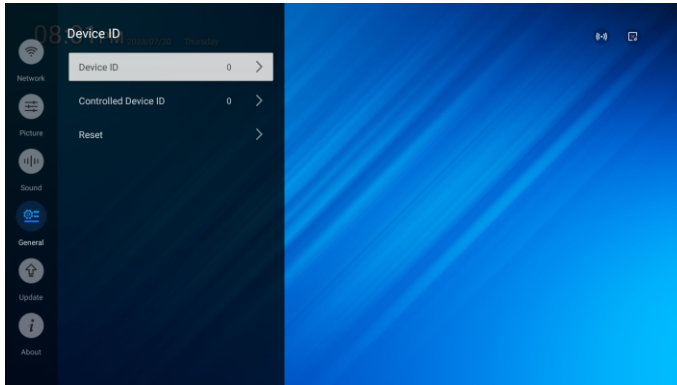

2.3.4.22 Settings- General- Engineering Menu- Anti-image-Sticking Mode

- Anti Image-Sticking Mode – To address the issue of screen burn or residual image ghosting.
- Manual Mode – Start the Anti Image-sticking Mode.
- Auto Mode On/Off.
 - Mode can be set to run according to a schedule.
- Duration – Length of time mode will run - 1/2/5/10 mins.
 - Run for longer duration if screen burn remains.
- Pattern – Select Test pattern to run.
 - Moving Bar.
 - Colour Bar – Select bar colour.
 - Default Video – Use default test patterns.
 - Custom Video.
 - Assign a custom video from internal storage.
 - Separate videos can be assigned for landscape and portrait orientation.

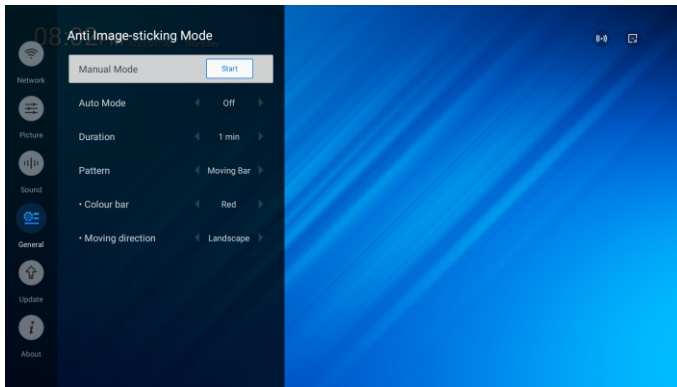

2.3.4.23 Settings- General- Engineering Menu- Signal Failover

- Signal Failover – set priority of input sources should an input signal fail.
- Input Source Priority – Off/On – Enable Signal Failover.
- Priority 1 – Set Input Signal Priorities (HDMI 1 / HDMI 2 / AV Input / Local Files) –.
- Priority 2 – Set Input Signal Priorities (HDMI 1 / HDMI 2 / AV Input / Local Files) –.
- Priority 3 – Set Input Signal Priorities (HDMI 1 / HDMI 2 / AV Input / Local Files) – .
- Internal Failover Signal Landscape – Select the Local File(s) to failover to – This can be a single movie file or a folder containing multiple files.
- Internal Failover Signal Portrait – As above, for portrait mode content.
- Supported file types mp4, 3gp, flv, mov.
- Adjust by selecting with 'OK' button on remote control and then use the direction 'right/left' on the remote control to change between the different statuses.

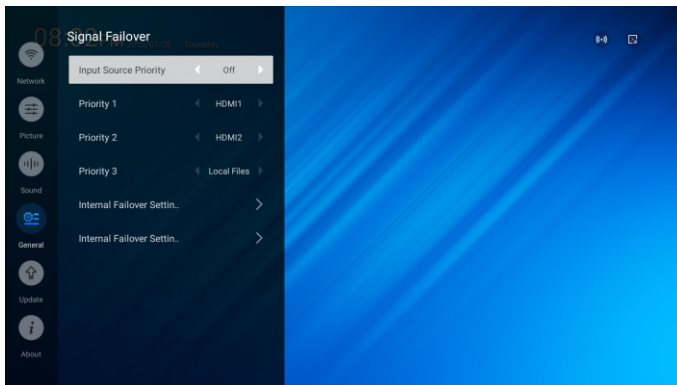

2.3.4.24 Settings- General- Engineering Menu- Boot Auto-Start

- Boot Auto-Start – Set which input source or app the panel should boot to from power on.
- Signal – Select an input signal to boot to.
 - HDMI 1
 - HDMI 2
 - AV
 - App
- Select from installed apps.
- Adjust by selecting with 'OK' button on remote control and then use the direction 'right/left' on the remote control to change between the different statuses.
 - Scroll up and down using the directional keys and the 'OK' button to select.

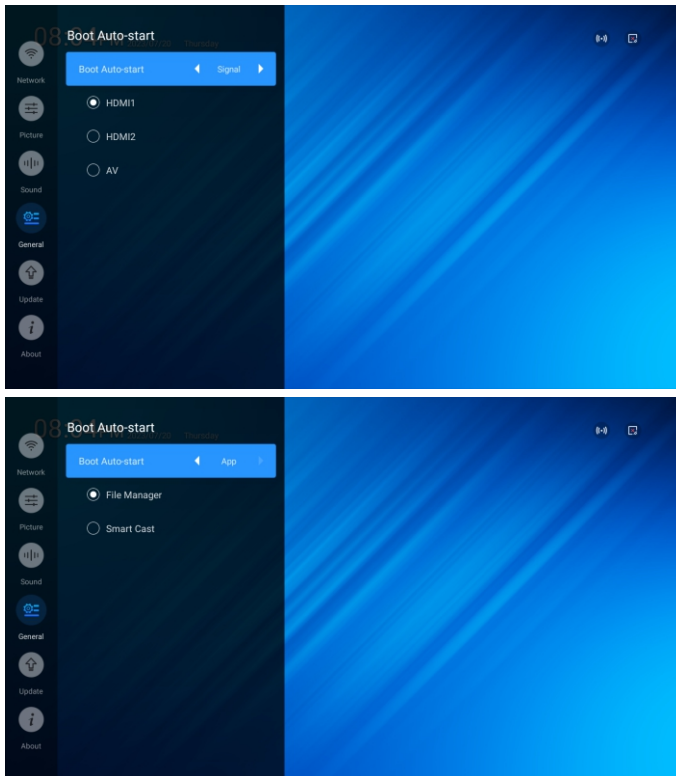

2.3.4.25 Settings- General- Engineering Menu- Boot Logo

- Boot Logo – Import an image or video file to display when panel boots.
 - Logo is displayed during power on.
 - Will replace the default logo.
 - Supported format mp4 less than 60s.
- Booting Logo Setting Landscape – Set Landscape mode custom boot logo.
- Booting Logo Setting Portrait – Set Portrait mode custom boot logo.
- Reset – restores the default boot logo.
- Adjust by selecting with 'OK' button on remote control and then use the direction 'right/left' on the remote control to change between the different statuses.

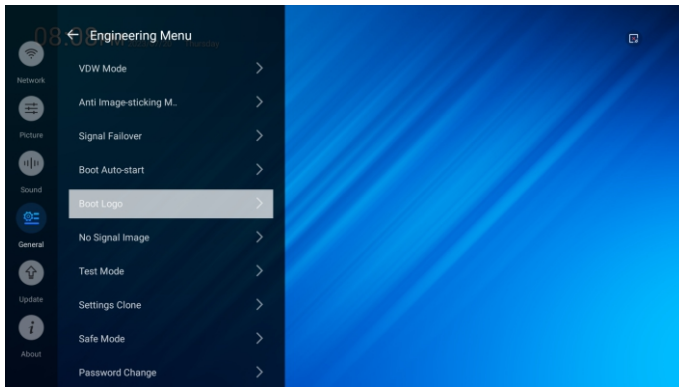

2.3.4.26 Settings- General- Engineering Menu- No Signal Image

- No Signal Image – Display a custom image if no signal is detected on HDMI/AV source.
 - Support format mp4, less than 60 sec.
- No Signal Source Setting Landscape – Set Landscape custom image.
- No Signal Source Setting Portrait – Set Portrait custom image.
- Reset – Clears the imported image(s) and reverts back to the default no signal image message.
- Adjust by selecting with 'OK' button on remote control and then use the direction 'right/left' on the remote control to change between the different statuses.

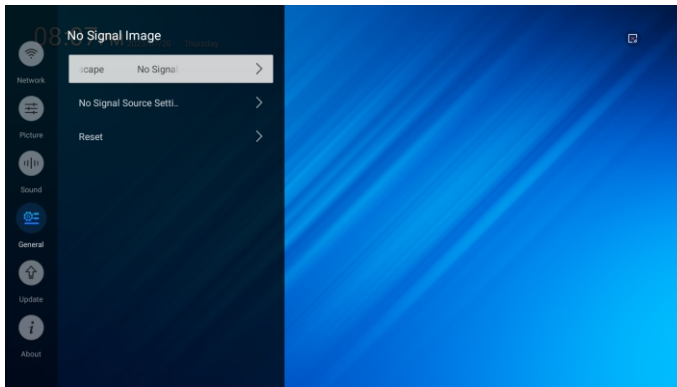

2.3.4.27 Settings- General- Engineering Menu- Test Mode

- Test Mode – Offers two different tests to be run to check the panel for running issues.
 - Visual Test – Display colour patterns on screen – Press L/R buttons to cycle through red/green/blue/white/greyscale.
 - Self-diagnostics – Runs a self diagnostic hardware check which is then saved to file.
 - Self-diagnostics Result – Opens File Manager - To view results select Self Test. xml.
 - Adjust by selecting with 'OK' button on remote control and then use the direction 'right/left' on the remote control to change between the different statuses.

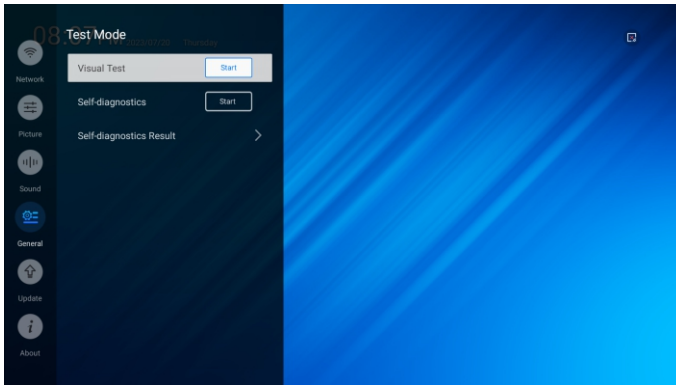

2.3.4.28 Settings- General- Engineering Menu- Safe Mode

- Safe Mode – Set control of the screen via remote control or panel buttons.
- Remote Key Lock On/Off – Enable/disable remote control.
 - NOTE – If setting is enabled, a USB mouse must be used to disable setting.
- Physical Key Lock On/Off – Enable/disable panel buttons.
 - NOTE – This model does not feature panel buttons.

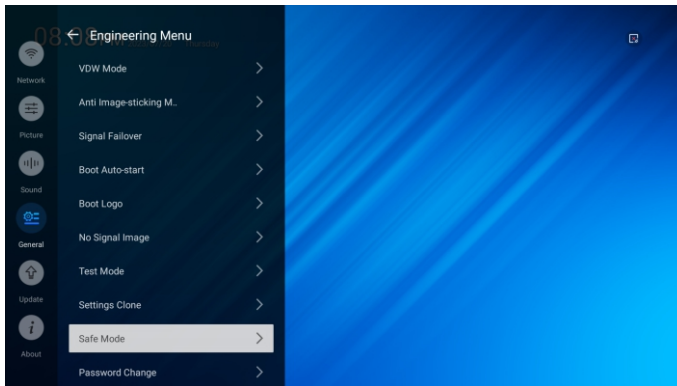

2.3.4.29 Settings- General- Engineering Menu- Password Change

- Password Change – Change the current 4 digit numeric password to access the engineering menu in the panel.
- Adjust by selecting with 'OK' button on remote control and then use the direction 'right/left' on the remote control to change between the different statuses.

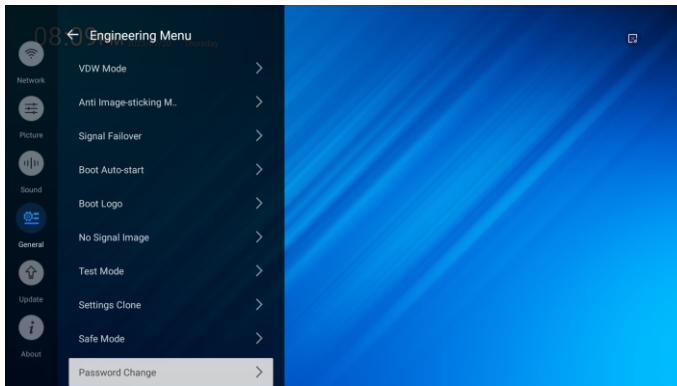

2.3.4.30 Settings- General- Reset

- Reset – Perform a complete system reset on the panel to restore it to factory conditions.
- All settings and data will be erased.
- Adjust by selecting with 'OK' button on remote control and then use the direction 'right/left' on the remote control to change between the different statuses.

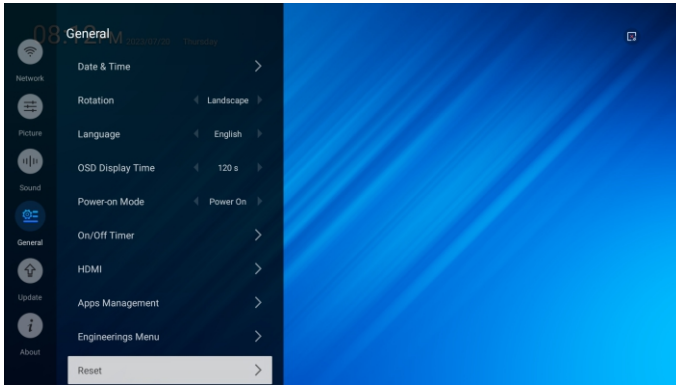

2.3.4.31 Settings- Update

- Update – perform a software update via either a local update or remote update.
- Local Update – Update the system software via a file loaded onto a USB Drive.
 - Displays the current version and release date of the software.
 - To update, put the update file in the root directory of a USB drive then select 'Confirm'.
- Remote Update – Update the system software via an Over The Air download.
 - Displays the current version and release date of the software.
 - To update, select 'Check Version' – this will inform you if your current software version is up to date or requires an update.
- Adjust by selecting with 'OK' button on remote control and then use the direction 'right/left' on the remote control to change between the different statuses.

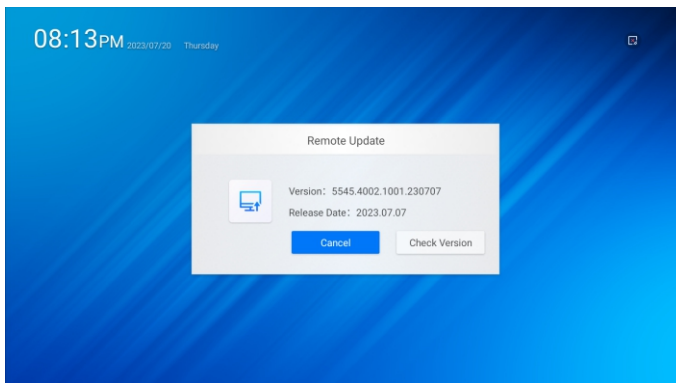
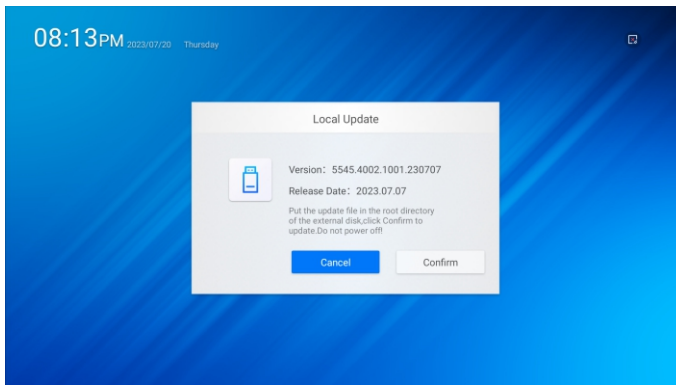

2.3.4.32 Settings-About

- About – Displays key device information about the panel.
 - Device Information
 - Product Number
 - Serial Number (if applicable)
 - Wireless MAC Address
 - LAN MAC Address
 - Display Parameters
 - Screen Size
 - Screen Resolution
 - Hardware Parameters
 - Main Processor
 - Image Processor
 - Running Memory
 - Storage Space (Available/Total)
 - System Messages
 - Android Version
 - System Version

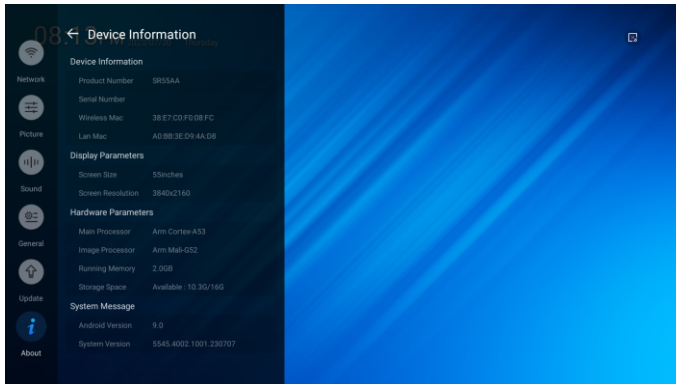

3. Technical Specifications

Due to continuous improvement of product performance, the product specification is subject to change without prior notice.

Display	Screen type	Thin film transistor (TFT) Liquid crystal display (LCD) screen
Video signal	Maximum resolution	HDMI1/HDMI2:3840x2160@60Hz AV-IN:720x576@60Hz Whether this function is supported depends on the operating system or graphics card type
	Recommended resolution	HDMI1/HDMI2:3840x2160@60Hz AV-IN:720x576@60Hz Whether this function is supported depends on the operating system or graphics card type
Input / output connection		LAN, LINE OUT, AV-IN/Audio-In, HDMI IN1, HDMI IN2
Embedded battery		Applicable
Environmental conditions	Working temperature	0°C~40°C
	Working humidity	20%~80% RH, non-condensing
	Storage temperature	-10°C~60°C
	Storage humidity	20%~80% RH, non-condensing

HDMI/AV (description of supported resolutions)		
Interface	Video mode	PC mode
HDMI	3840x2160p@60Hz	3840x2160@60Hz(VESA)
	1920x1080p@60Hz	1680*1050@60Hz (VESA)
	1920x1080p@50Hz	1360*768@60Hz (VESA)
	1920x1080p@24Hz	1280*1024@60Hz (VESA)
	1920x1080p@30Hz	800*600@60Hz (VESA)
	1920x1080i@60Hz	640*480@60Hz (VESA)
	1920x1080i@50Hz	
	1280x720p@50Hz	
	1280x720p@60Hz	
	720x480i@60Hz	
	720x480p@60Hz	
	640x480p@60Hz	
	720x576p@50Hz	
	720x576i@50Hz	
AV	720x576@60Hz	720x576@60Hz
<p>Note: The maximum resolution in horizontal screen mode is 3840x2160@60Hz The maximum resolution in vertical screen mode is 2160x3840@60Hz</p>		

Only in the table resolution is supported

MICRO SD description	
File system format	Maximum storage capacity
NTFS	128GB
FAT32	32GB

SR43AA		
LCD Panel	Pixel pitch	81.7 (H)X245.1 (V)
Power supply	Power input	100V~240V,50/60Hz
	Power consumption	Power-on status: $\leq 110W$
		Sleep mode $\leq 0.5W$
Dimension (width × height × depth)	Complete machine	956.2 x 546.2 x 89mm
		Mass

SR49AA		
LCD Panel	Pixel pitch	279.63(H)X279.63(V)
Power supply	Power input	100V~240V,50/60Hz
	Power consumption	Power-on status: $\leq 165W$
		Sleep mode $\leq 0.5W$
Dimension (width × height × depth)	Complete machine	1088 x 619.1 x 89mm
		Mass

SR55AA		
LCD Panel	Pixel pitch	315(H)X315(V)
Power supply	Power input	100V~240V,50/60Hz
	Power consumption	Power-on status: $\leq 160W$
		Sleep mode $\leq 0.5W$
		Power-off mode $\leq 0.5W$

Dimension (width × height × depth)	Complete machine	1224.6 X 698 X 89mm
Mass		11.9 KG
SR65AA		
LCD Panel	Pixel pitch	124(H)X3(RGB)X372(V)
Power supply	Power input	100V~240V,50/60Hz
	Power consumption	Power-on status: ≤ 215W
		Sleep mode ≤ 0.5W
		Power-off mode ≤ 0.5W
Dimension (width × height × depth)	Complete machine	1443.7 x 820.2 x 89mm
Mass		15.9KG
SR75AA		
LCD Panel	Pixel pitch	429.6(H)X429.6(V)
Power supply	Power input	100V~240V,50/60Hz
	Power consumption	Power-on status: ≤ 290W
		Sleep mode ≤ 0.5W
		Power-off mode ≤ 0.5W
Dimension (width × height × depth)	Complete machine	1664.9 x 945.6 x 89mm
Mass		21.0KG
SR86AA		
LCD Panel	Pixel pitch	493.5(H)X493.5(V)
Power supply	Power input	100V~240V,50/60Hz
	Power consumption	Power-on status: ≤ 380W
		Sleep mode ≤ 0.5W
		Power-off mode ≤ 0.5W
Dimension (width × height × depth)	Complete machine	1916.3 x 1087.3 x 89mm
Mass		45.0KG

4. Serial Port Control Protocol

RS232 serial port is defined as follows:

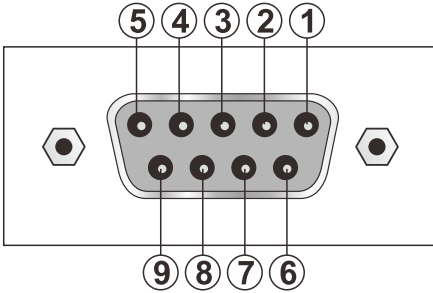

Baud rate: 115200
 Data length: 8
 Parity bit: None
 Stop bit: 1
 Flow control: None
 Communication code: ASCII

Classification	Item	Baud rate	Command	Data (Hex.)
Power supply	Power-on		99 FF	None
	Power-off		F1 01	None
Signal source	HDMI1		F2 01	31
	HDMI2		F2 01	32
	AV		F2 01	33
Image settings	Image mode		F3 01	Refer to the "Image Mode"
	Brightness		F3 02	00 - 64
	Backlight		F3 03	00 - 64
	Contrast		F3 04	00 - 64
	Sharpness		F3 05	00 - 14
	Color temperature	F3 06	Refer to the "Color temperature"	
	Aspect ratio	F3 07	Refer to the "Aspect ratio"	

Audio setting	Volume +	F4 01	30
	Volume -	F4 01	31
	Mute/unmute	F4 02	None
White balance calibration	R Gain	F5 01	Refer to the "White balance calibration"
	G Gain	F5 02	Refer to the "White balance calibration"
	B Gain	F5 03	Refer to the "White balance calibration"

Instruction format:

[Instruction header] [Data direction] [Command ID_1] [Command ID_2]
[Device ID] [Data length] [Data] [End]

[Instruction header]: Byte_1, instruction start, fixed to 42; [Data direction]: Byte_2; instruction sending direction; the upper computer sends instructions to the device, fixed to 01; [Command ID_1] [Command ID_2]: Byte_3, Byte_4, ID of specific command in the instruction;

[Device ID]: Byte_5; the ID of the device to be controlled by the instruction; the value range is 00 – FF (0 - 255); when the device ID carried in the instruction is 00, all devices can be operated;

[Data length]: Byte_6, the length of carried valid data; if there is no valid data, this value is 00;

[Data]: Valid data; the length of data bytes is configured through the bytes of [Data length], and multiple data are separated by spaces;

[End]: Instruction end byte, fixed to FF.

01.Power-on:

Used to control power-on of the product.

Instruction: 99 FF

02.Power off:

Used to control power-off of the product

Instruction: 42 01 F1 01 [Device ID] 00 FF

03.Signal source:

Used to select the input signal source of the product. Instruction: 42 01 F2 01 [Device ID] 01 [Data] FF

Data:

HDMI1:31

HDMI2:32

AV:33

04. Image mode

Used to select the image mode of the product

Instruction: 42 01 F3 01 [Device ID] 01 [Data] FF

Data:

Standard mode: 31

Soft mode: 32

User mode: 34

Natural mode: 35

Vivid mode: 33

05. Brightness

Used to set the brightness of the product

Instruction: 42 01 F3 02 [Device ID] 01 [Data] FF

06. Backlight:

Used to set the backlight of the product

Instruction: 42 01 F3 03 [Device ID] 01 [Data] FF

07. Contrast

Used to set the contrast of the product

Instruction: 42 01 F3 04 [Device ID] 01 [Data] FF

08. Sharpness

Used to set the sharpness of the product

Instruction: 42 01 F3 05 [Device ID] 01 [Data] FF

09. Color temperature

Used to select the color temperature of the product

Instruction: 42 01 F3 06 [Device ID] 01 [Data] FF

Data:

Standard: 31

Cold color: 33

Warm color: 32

10. Aspect ratio

Used to select the aspect ratio of the product

Instruction: 42 01 F3 07 [Device ID] 01 [Data] FF

Data:

Automatic: 33

16:9: 32

4:3: 31

11. Volume +

Used to increase the volume of the product

Instruction: 42 01 F4 01 [Device ID] 01 30 FF

12. Volume -

Used to reduce the volume of the product

Instruction: 42 01 F4 01 [Device ID] 01 31 FF

13. Mute/unmute

Used to mute and unmute the product

Command: 42 01 F4 02 [Device ID] 00 FF

14. White balance calibration

Used to set the white balance value of the product

R Gain:

Instruction: 42 01 F5 01 [Device ID] 02 [Data symbol bit] [Data value] FF

Data symbol bit:

Positive number symbol: 31

Negative number symbol: 30

Data value: 00 - 32

G Gain:

Instruction: 42 01 F5 02 [Device ID] 02 [Data symbol bit]

[Data value] FF

Data symbol bit:

Positive number symbol: 31

Negative number symbol: 30

Data value: 00 - 32

B Gain:

Instruction: 42 01 F5 03 [Device ID] 02 [Data symbol bit]

[Data value] FF

Data symbol bit:

Positive number symbol: 31

Negative number symbol: 30

Data value: 00 - 32

5. Cleaning and Troubleshooting

5.1. Cleaning

Precautions for use of the display

- Do not put your hands, face or other objects near the vent hole of the display. Due to the high-temperature gas discharged from the vent hole, the top of the display is usually very hot. If any part of your body is too close to this position, you may be burnt. If any object is placed on the top of the display, the object or the display itself may also be damaged due to high temperature.
- Be sure to disconnect all cables before moving the display. If you move the display while the cables are connected, the cables may be damaged, and fire or electric shock may be caused.
- For safety, the power plug shall be unplugged from the wall socket before any type of cleaning or maintenance operation.

Instructions for front panel cleaning

- The front of the display has been specially treated. Please only use cleaning cloth or soft cloth free from hair shedding to gently wipe the surface.
- If the surface becomes dirty, soak the soft cloth in a mild detergent then wring the cloth dry. Wipe the display surface to remove dirt. Then gently wipe it dry with a different clean soft cloth.
- Do not scratch or knock the panel surface with your fingers or any other hard object.
- Do not use volatile substances such as spraying agents, solvents and thinners.

Instructions for shell cleaning

- If the shell becomes dirty, use soft and dry cloth to wipe it.
- If the shell is very dirty, soak the cloth free of hair shedding in mild detergent, wring it dry, wipe the shell, and then use another dry cloth to dry it.
- Do not let any water or detergent stay on the display surface. If water or moisture enters the equipment, operation problems and electric shock hazard may be caused.
- Do not scratch or knock the shell with your fingers or any other hard object.
- Do not use volatile substances such as spraying agents, solvents and thinners on the shell.
- Do not place any plastic or PVC products near the shell for a long time.

5.2. Troubleshooting

Fault	Possible causes	Solutions
No display on the screen	<ol style="list-style-type: none"> 1. The power cord is disconnected. 2. The main power switch on the back of the display is not turned on. 3. The selected input is not connected. 4. The display is in standby mode. 	<ol style="list-style-type: none"> 1. Connect the power cord. 2. Ensure that the power switch is on. 3. Connect the signal to the display. 4. Ensure IR Receiver is correctly connected and placed in a location visible to the IR remote. The IR Remote should turn the set on as long as IR receiver is visible to it.
Interference appears on the display or noise can be heard	It is caused by surrounding electrical equipment or fluorescent lamps.	Move the display to other location to see if the interference can be reduced.
The color is abnormal	The signal cable is not connected correctly.	Ensure that the signal cable is firmly connected to the back of the display.
The screen is distorted with abnormal patterns	<ol style="list-style-type: none"> 1. The signal cable is not connected correctly. 2. The input signal exceeds the capacity of the display. 	<ol style="list-style-type: none"> 1. Ensure that the signal cable is firmly connected. 2. Check the video signal source to see if it is out of the range of the display. Please specifications of check the this display according to the section of technical specifications.
Sound can be heard, but there is no image	The signal cable of input source is not connected correctly.	Ensure the video input and audio input is connected correctly.
Image can be seen but sound cannot be heard	<ol style="list-style-type: none"> 1. The signal cable of input source is not connected correctly. 2. The volume is turned to the minimum. 3. The digital audio output is turned on, e.g. PCM output is turned on. 	<ol style="list-style-type: none"> 1. Ensure the video input and audio input is connected correctly. 2. Press the [-/+] button and you can hear the sound. 3. Turn off the sound output in the sound settings.

└ Paste S/N code